

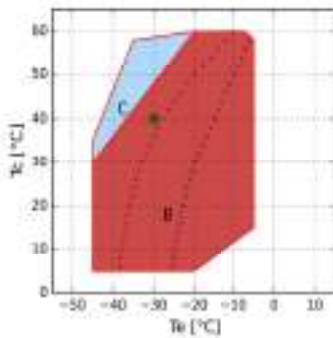

Calculation - H

Input

Model	H2700CS
Refrigerant	R404A
Evaporating temperature	-30.0 °C
Condensing temperature	40.0 °C
Reference temperature	Dew temperature
Suction temperature	20.0 °C
Evaporator outlet temperature	20.0 °C
Liquid subcooling	0.0 K
Voltage / phases / frequency	380-420 V / 3 / 50 Hz
Capacity control system	100%



- B = Standard application
- C = Head cooling fan or max superheating 20K
- x = Min Te 50%
- * = Min Te 50% Head cooling fan or max superheating 20K
- = Dew temperature

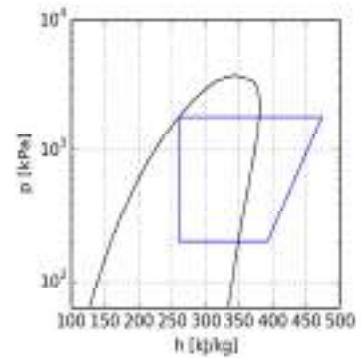

Performance calculation

	Standard conditions	At evaporator	At compressor
Cooling capacity	22490 W	22490 W	22490 W
Absorbed power	12.16 kW	12.16 kW	12.16 kW
Condenser capacity	34.64 kW	34.64 kW	34.64 kW
COP	1.85	1.85	1.85
Mass flow	609.9 kg/h	609.9 kg/h	609.9 kg/h
Absorbed current	26.2 A	26.2 A	26.2 A
Discharge temperature	100.8 °C	100.8 °C	100.8 °C
Max operating current	48.0 A	48.0 A	48.0 A
Locked rotor current	203.0 A	203.0 A	203.0 A



Technical data

No. cylinders	4.0	
Bore	75.0	[mm]
Stroke	60.0	[mm]
Displacement @ 50 Hz	92.25	[m ³ /h]
Displacement @ 60 Hz	110.7	[m ³ /h]
Suction valve	54 s.	[mm]
Discharge valve	35 s.	[mm]
Oil charge	3.5	[L]
Net weight	200.0	[kg]

Overall dimensions [mm]

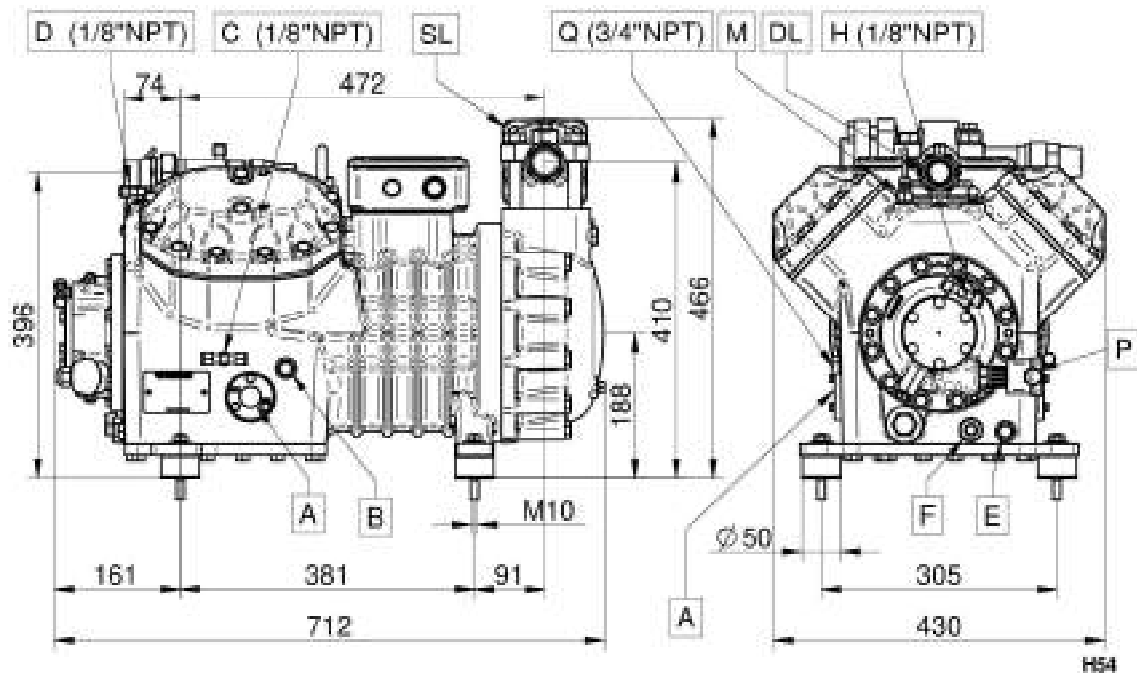

A - Oil sight glass

B - Oil charge plug

C - Low pressure connection

D - High pressure connection

E - Oil drain plug

F - Crankcase heater

G - Oil return plug

H - Oil pressure tap

M - Max. discharge temperature sensor

P - Oil differential pressure switch

Q - Gas equalisation

DL - Discharge service valve

SL - Suction service valve



Configuration: Standard \ Optional

TE=Thermistor protection	Standard
REL=Motor protection electronic module	Standard
CH=Crankcase heater	Optional
TCH=Self-regulated crankcase heater	Optional
SLCR=Stepless capacity regulator	Optional
BF=Head cooling fan	Optional
US=Unloaded start by-pass	Optional
ISV=Internal safety valve	Standard
IP65=Electrical box IP65	Standard
CR1=Capacity control 50-100%	Optional
UL=UL approved compressor	Optional
ODPS=Oil differential pressure switch	Standard
TMAX=Max discharge temperature sensor	Standard
For operation with HFC refrigerants the compressor must be ordered with POE OIL. For operation with HCFC refrigerant the compressor shall be ordered with mineral oil.	
HFC (POE 32) - HCFC (MIN 32)	Standard
Motors suitable for operation at different voltage from those listed above may be supplied on request.	
For low temperature application external cooling must be provided.	
220-240/3/50 (Δ) 380-420/3/50 (Y)	Optional
265-290/3/60 (Δ) 440-480/3/60 (Y)	Optional
380-420/3/50 (PWS) 440-480/3/60 (PWS)	Standard
208-230/3/60 (Δ) 360-400/3/60 (Y)	Optional
208-230/3/60 (PWS)	Optional
220-240/3/50 (PWS)	Optional
360-400/3/60 (PWS)	Optional
475-525/3/50 (PWS) 570-630/3/60 (PWS)	Optional