

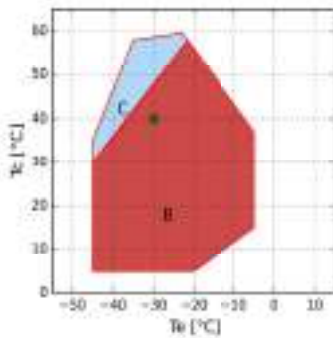

## Calculation - H

### Input

Model	H101CS
Refrigerant	R404A
Evaporating temperature	-30.0 °C
Condensing temperature	40.0 °C
Reference temperature	Dew temperature
Suction temperature	20.0 °C
Evaporator outlet temperature	20.0 °C
Liquid subcooling	0.0 K
Voltage / phases / frequency	380-420 V / 3 / 50 Hz
Capacity control system	100%



B = Standard application  
 C = Head cooling fan or max superheating  
 20K  
 • = Dew temperature

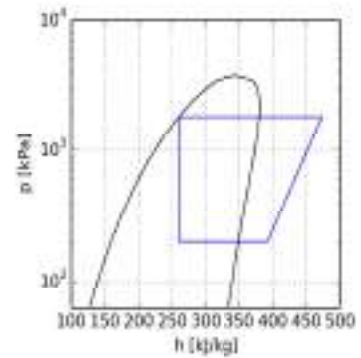

### Performance calculation

	Standard conditions	At evaporator	At compressor
Cooling capacity	1390 W	1390 W	1390 W
Absorbed power	1.00 kW	1.00 kW	1.00 kW
Condenser capacity	2.38 kW	2.38 kW	2.38 kW
COP	1.38	1.38	1.38
Mass flow	37.5 kg/h	37.5 kg/h	37.5 kg/h
Absorbed current	2.1 A	2.1 A	2.1 A
Discharge temperature	120.4 °C	120.4 °C	120.4 °C
Max operating current	2.9 A	2.9 A	2.9 A
Locked rotor current	13.8 A	13.8 A	13.8 A



Technical data

No. cylinders	2.0	
Bore	38.0	[mm]
Stroke	34.0	[mm]
Displacement @ 50 Hz	6.71	[m <sup>3</sup> /h]
Displacement @ 60 Hz	8.05	[m <sup>3</sup> /h]
Suction valve	16 s.	[mm]
Discharge valve	12 s.	[mm]
Oil charge	1.0	[L]
Net weight	37.0	[kg]

Overall dimensions [mm]

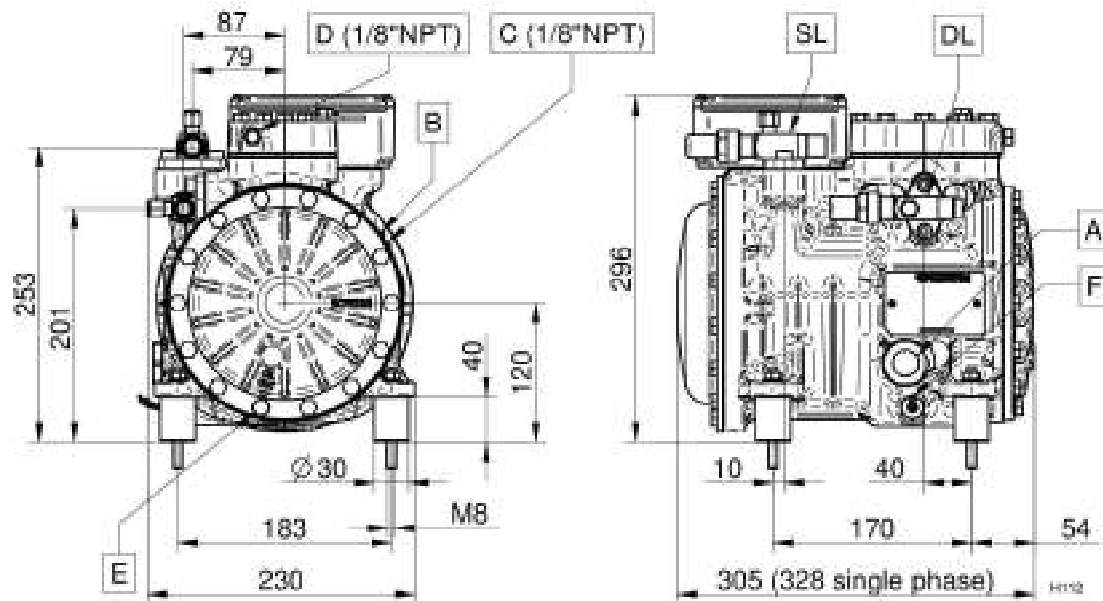

A - Oil sight glass

B - Oil charge plug

C - Low pressure connection

D - High pressure connection

E - Oil drain plug

F - Crankcase heater

DL - Discharge service valve

SL - Suction service valve



Configuration: Standard \ Optional

TE=Thermistor protection	Standard
TK=Thermik protection	Optional
REL=Motor protection electronic module	Standard
CH=Crankcase heater	Optional
TCH=Self-regulated crankcase heater	Optional
BF=Head cooling fan	Optional
WH=Water cooled head	Optional
IP65=Electrical box IP65	Standard
UL=UL approved compressor	Optional
CB=CB approved compressor	Optional
CCC=CCC approved compressor	Optional
For operation with HFC refrigerants the compressor must be ordered with POE OIL. For operation with HCFC refrigerant the compressor shall be ordered with mineral oil.	
HFC (POE 32) - HCFC (MIN 32)	Standard
Motors suitable for operation at different voltage from those listed above may be supplied on request.	
For low temperature application external cooling must be provided.	
220-240/1/50	Optional
115/1/60	Optional
220-240/3/50 (Δ) 380-420/3/50 (Y)	Standard
208-230/1/60	Optional
265-290/3/60 (Δ) 440-480/3/60 (Y)	Optional
475-525/3/50 570-630/3/60	Optional
200/3/50-60 (Δ)	Optional
208-230/3/60 (Δ) 360-400/3/60 (Y)	Optional